

USER MANUAL



OPTIMA 312 – ES960C circuit board

TABLE OF CONTENTS

1. Installation of Optima Design	3
1.1 Installation of the Control Panel	3
1.2 Mounting	3
2. Control Panel	4
3. Installation	4
4. Start-up	5
5. Operation	6
5.1 Operating and Changing Data in the Operating Menu	6
5.2 Main Menu	7
5.3 Date and Time	7
5.4 Calendar	8
5.5 User Menu.....	8
5.6 Display Menu	9
5.7 Info Menu	10
5.8 Service Menu	11
5.9 Schedule for Week Program	17
5.10 Defrosting Schedule	17
5.11 Set Point Schedule	18
6. Function	20
6.1 Operation of Optima 312.....	20
6.2 Extra Capacity	20
6.3 Operating Reliability.....	20
7. Maintenance	21
7.1 Unit.....	21
7.2 Water Circuit and Boiler	21
7.3 Dismantling/Taking the System Out of Service	21
8. Troubleshooting	22
8.1 High-Pressure Pressure Switch.....	22
8.2 Immersion Heater's Safety Thermostat	22
8.3 System Is Not in Operation	22
8.4 Air Faults	22

1. INSTALLATION OF OPTIMA DESIGN

1.1 Installation of the Control Panel

The control panel is designed to be mounted onto a level wall.

1.2 Mounting

Find the installation place for the control panel, mark off the holes and screw the the fixture securely onto the wall. Use at least 4 screws for securing the panel, two at the top and two at the bottom.

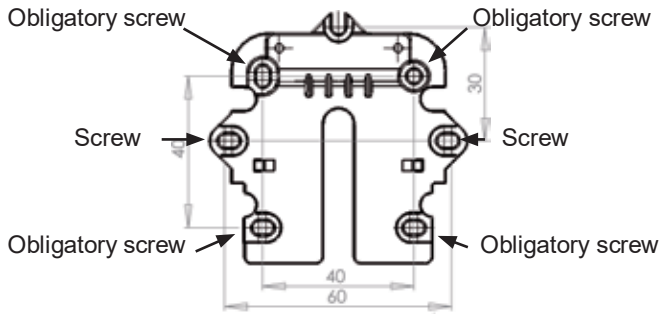

Hold up the wall frame against the wall and mark off the holes for fastening the frame. Drilling of holes, hole size and suitable screws for fixing the panel all depend on the wall material.

Place the control panel in the fixtures and tilt it in against the wall. The four support points in the corners of the display must touch the wall to keep the display stable.

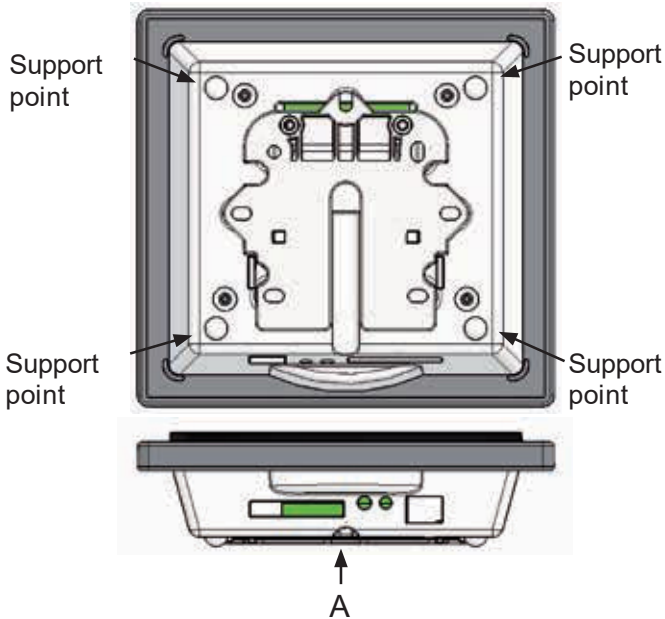

Underneath the control panel there is access for the:
A: Terminal block. Connection to main circuit board
 Fit a 4 x 0.25 mm² low-current cable between the unit and the control panel. The maximum cable length is 50 m. The voltage drop for cable lengths over 50 m is too high and can cause operating trouble.

Method of Installation of the Wall Fixture:

First screw the fixture securely onto a level wall and then guide the cable visibly up from below.

Connect the low-current cable to the terminal block. Check that the cable is connected to the same numbers at both ends (between the control panel and the main circuit board in the unit.)

Clip the control panel to the wall fixture by guiding it down from above, slightly slanting out at the bottom. Finish by pressing it in at the bottom so that it is flat against the wall. To disassemble, pull the control panel slightly slanting out at the bottom and lift up.

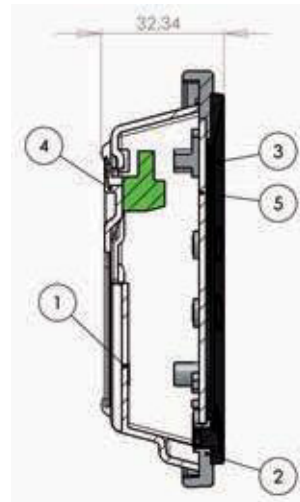

Position	Description
1	Panel casing
2	Front of panel
3	Display pressure plate
4	Wall fixture
5	Display glass

2. CONTROL PANEL

The control panel must be mounted on an interior wall that is centrally located in the home. Since the control panel can simultaneously function as a room thermostat, it is important to observe, as follows (unless extract air temperature control unit is used):

- **Do not expose the control panel to direct sunlight**
- **Do not place the control panel on an outer wall**
- **Do not recess the control panel in the wall**
- **Do not place the control panel over a heat source**

A lamp close to the control panel can affect the light sensor and prevent the control panel from regulating the light intensity as intended.

7 keys used for operating the panel are placed on the front of the control panel in the ring. The function of the keys changes depending on the menu selected. (More information is available under Operation.)

There is an infrared movement sensor located under the glass screen.

You can bring up the menu for the daily operating options by just waving your hand by the control panel (it is possible to turn this function off: See under Main menu/Display/Menu item 5).

The following components are placed at the bottom of the control panel:

1. SD card
2. Room sensor
3. Light sensor
4. Mini USB port for connection to computer

1: The removable SD card contains all the control models and versions, which makes the control panel compatible with older versions. The SD card also contains all the languages, menus, help texts, symbols and collected data logs. The current versions are installed in the control panel during the start-up procedure so that the control unit can function without the SD card. However, the help texts will not appear in the display, and the data logs will not be saved.

See the installation guide.

3. INSTALLATION

4. START-UP

The first time the system is started, the control panel display will show: "Choose language".

Click "Next" to switch among Danish, English, German and French. Press "Enter" when your desired language is shown in the display. The control panel will now load the current program version in the selected language.

The display will show:

- Updating model (loading the current model)
- Wait 1.5 minutes (It takes approximately 1.5 minutes to load the current version)
- Language load (91)
- Language OK
- Menu load (84)
- Menu OK
- Icon load (369)
- Menu OK
- Reset to default
- Restarting.....
- Optima 312 UK

The display will then change to:

- Optima 312 UK
 - Version number
- D (Control panel): X.X
C (Main board): X.X

Finally, the display changes to daily operation, and the system is now in operation with the factory setting, which is only a basic setting.

The system is now ready to be fine-tuned with the most optimal air flows and operational desires and demands for the dwelling in question, e.g. weekly operation, temperatures, etc. to ensure that the system is used and operated as optimally as possible.

5. OPERATION

Optima 312

All combined ventilation units and domestic hot water heat pumps of the Combi 185 BP type for dwellings are supplied with the Optima 312 control unit, which has a factory setting, which means that the system can be put into operation without further setup.

The factory setting is a basic setting that should be adapted to the operating desires and demands for the home in question to ensure that the system is used and operated as optimally as possible.

5.1 Operating and Changing Data in the Operating Menu

Normally the symbols for the daily operating options are displayed, and the following keys are visible:

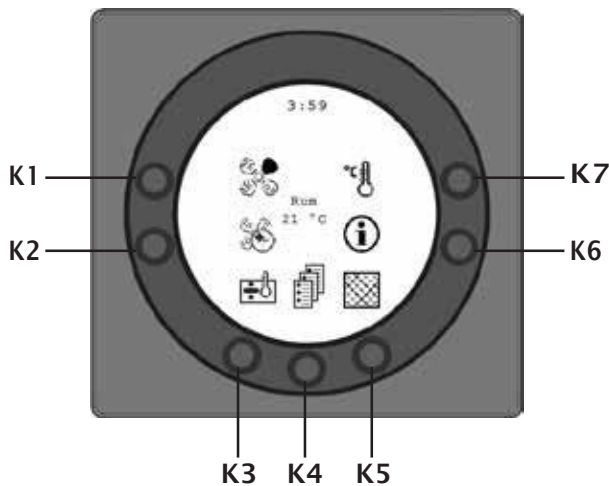

K1 - Speed

Use this function to set the fan speed to levels 0-1-2-3-4.

Use the key next to the “Speed” symbol to change among the 4 speeds. It is also possible to stop the system by pressing and holding the key for 3-4 seconds on condition that item 28 of the Service menu is set to ON.

K2 - Forced operation (Party mode)

This feature makes it possible to set the timer for forced operation to between 0 and 9 hours.

Use pushbutton K2 to switch from 0 to 9 hours.

If the number of hours is set to 0, speeds 3 and 4 will run until the speed is changed manually. If the number of hours is set to between 1 and 9 hours, speeds 3 and 4 will automatically reconnect to speed 2 after the set number of hours.

K3 - Immersion heater

Use the key next to the symbol “Immersion heater” to change between + and ÷. If the symbol is set to “+”, the immersion heater will automatically engage, as required. If the symbol is set to “÷”, the immersion heater will not engage, even if required. It is a precondition that item 3 in the User Menu is set to ON.

K4 - Main Menu

Use this function to enter the main menu and access the sub-items Date and time, Calendar, User menu, Display, Info menu and Service menu.

K5 - Filter

Use this function to reset the filter alarm.

The key next to the “Filter” symbol resets the alarm for filter change. To reset the filter alarm, first change the filters and press and hold the key with the “Filter” symbol until the exclamation mark in the symbol disappears.

K6 - Information

Use this function to get an overview of the current operating condition of the unit, e.g. temperatures, fan settings, relay status/function ON/OFF, alarms, timers, etc. Use the key next to the symbol “Info” to read off the operating condition of the unit. More information can be found in the main menu section under the item Info operation.

K7 - Temperature

Use this function to set the room temperature. Press the key next to the “Temperature” symbol to enter a desired temperature between 10 and 30 °C. The current temperature will be displayed in the centre of the screen.

Press the K4 key to enter the main menu and sub-menus, where the following keys will change function:

K3 changes to “Arrow down” and when the setting is changed to “÷”.

K4 changes to “Enter”. Press “Enter” to proceed through the menus and sub-menus.

K5 changes to “Arrow up” and when the setting is changed to “+”.







K6 changes to “Exit”. Press “Exit” to return to the previous screen.

K7 changes to “Help”. Press “Help” to view a short description of the current menu item.

The horizontal arrow in the menu shows the current location. To save changes to a menu item, finish by pressing “Enter”.

5.2 Main Menu

There is a "Book" K4 symbol lowermost in the centre of the screen underneath the daily operating options. It provides access to the main menu. Press this key to enter the main menu.

-  Date and time (item 4.3)
-  Calendar (item 4.4)
-  User menu (item 4.5)
-  Display (item 4.6)
-  Info operation (item 4.7)
-  Service menu (item 4.8)

"Arrow down" or "Arrow up" will change the symbol to a horizontal arrow that indicates the current location.



Press "Enter" to access the sub-items of the current menu. Press "Arrow down" or "Arrow up" again to select the required sub-menu item. When the horizontal arrow is next to a sub-menu item, the 2 lines will change place, the font sizes will change, and the text "Set" will be added. Pressing "Enter" next to the selected sub-menu item will change the background of the item to grey. Use the "+" and "-" keys to change the current value. Press "Enter" again to save the change. If no changes are required, press "Exit" to go back out of the menus.

Press "Help" to view a short help text about the menu item on the screen. Press one of the keys to exit the help program.

If none of the keys is pressed within a short period of time, the control unit will automatically exit the programs.

5.3 Date and Time

Use this function to set and change the date and time.

01 Timer

Use this field to input the current hour. When switching between summer and winter time, you have to set the time one hour forward or back manually.

02 Minutes

Use this field to input the current minute.

03 Weekday

Use this field to input the current weekday.

04 Date

Use this field to input the current date.

05 Month

Use this field to input the current month.

06 Year

Use this field to input the current year.

Weekday

Monday	1
Tuesday	2
Wednesday	3
Thursday	4
Friday	5
Saturday	6
Sunday	7

Month

January	1
February	2
March	3
April	4
May	5
June	6
July	7
August	8
September	9
October	10
November	11
December	12

5.4 Calendar

Use this function to configure and change the setting of each day of the week. Each day can be configured to run at different fan speeds, as required. It is possible to copy the configuration from one weekday to another. Here it is also possible to choose ON or OFF, i.e. if there is nobody home for a period of time, the daily settings can be turned off, and the system will run according to a manual setting, for example, level 1.

01 - Calendar

Choose between controlling the system manually or controlling the speed (air exchange) and temperature automatically, according to a fixed weekday program.

If the menu item is set to OFF, the system will be controlled manually according to the selected speed and temperature. If the menu item is set to ON, the system will be controlled according to the weekday programs entered in menu items 02 to 08.

Setting range: ON/OFF.
Factory setting: OFF.

02 - Monday

Up to 10 switching times can be entered for one day. The times can be input in a random order. Enter the hours in the first column, the minutes in the second and the speed in the third column. Use the fourth column to input the temperature difference by which the temperature should be lowered.

Example: If the temperature is set to 21 °C and you enter - 2.0 °C, the system will aim at 19 °C.

If the speed has been changed manually with the key during the daily operation, the program will return to the weekday program when the next switching time passes.

Examples of a weekday program:

01 07:30 H3 - 0.0
02 09:15 H1 - 1.0
03 17:00 H3 - 0.0
04 18:00 H2 - 0.0
05 23:30 H2 - 2.0

It is not necessary to use all switching times. If there is 0 in the entire line, the control unit will skip it.

03 to 08

These days can be filled in individually in the same way as under item 02.

09 - Copy day

Use this menu item to copy one day of the week to another, where the same switching times, speeds and temperature lowering are required. Example: From Thursday to Tuesday

5.5 User Menu

01 - Temperature

Use this field to set the room temperature. The room sensor is installed in the control panel.

Setting range: between 10 and 30 °C.
Factory setting: 21 °C.

02 - Domestic water

Use this field to set the desired domestic hot water temperature.

Setting range: between 0 and 55 °C.
Factory setting: 52 °C.

03 - Immersion heater

By configuring the set point to "ON", the immersion heater will automatically engage, if necessary. If the set point is configured to "OFF", the immersion heater will not engage, even if there is a need for this.

When the fresh air temperature is below 0 °C, it is recommended to connect the immersion heater as a supplement to the heating of the domestic hot water, thereby reducing the heating time.

Setting range: ON/OFF.
Factory setting: OFF.

04 - Timer levels 3 and 4

If the unit runs at speed 3 and 4 and the set point is set to ON, the unit will automatically reconnect to speed 2 after the number of hours set in item 17 of the Service Menu. If the set point is set to OFF, the system will run at speed 3 or 4 until it is manually changed to another speed. The timer can also be operated directly, with the key next to the symbol for "Party mode" on the screen for daily operating options.

Setting range: ON/OFF.
Factory setting: OFF.

05 - Filter change

There is a built-in filter timer that counts how long the system has been running since the most recent filter change.

The set point can be set to between 1 and 12 months. We recommend that the set point be initially set at 3 (3 months).

If the filters are too dirty after the set period, it is possible to set the set point to a lower number of months. If it is not necessary to change the filters after the set period, the set point can be set to a higher number of months.

When the timer reaches the set value for filter change, the "Change filter" alarm will flash at the top of the screen saver.

Once the filters are changed, return to the screen with daily operating options and press and hold the key for the "Filter" symbol until the exclamation mark disappears and the system returns to normal operation.

Setting range: Between 1 and 6 months. Input 0 in the filter alarm to deactivate it.

Factory setting: 3.

06 - Fugtighedsstyring

Her slås fugtighedsstyringen til. Den skal være indstillet til ON for at være aktiveret.

NB: fugtstyring er kun aktiv i trin 2 og trin 3 og kun når varmepumpen ikke er aktiv. Funktionen er kun mulig på Combi med fugtføler.

Indstillingsmulighed: ON/OFF.

5.6 Display Menu

Use the Display menu to set and change the following sub-menu items:

01 - Language

Use this option to choose among several different languages in the display.

02 - Program info

Use this option to view what Optima is installed on the unit and what is its version number:

Example: Optima 312 UK D: 3.1 C: 1.0

D stands for the version number of the control panel.

C stands for the version number of the main board.

03 - Screen saver

Use this option to select the following settings:

0: Screen saver off.

(ON and displaying daily operating options)

1: Screen saver off, but with light dimming

2: Room temperature + light dimming

3: Clock + light dimming

4: Clock and room temperature + light dimming

5: Black screen + light dimming

Setting range: between 0 and 5.

Factory setting: 3.

04 - Pause time

Use this option to set how long it should go from no operation of the symbols on the screen for daily operation until the screen automatically returns to the screen saver. The time to go from daily menu to screen saver can vary from 1

to 10 minutes. The other automatic return connections cannot be adjusted. If no key has been pressed within the time intervals indicated below, it will automatically return to the previous screen:

- Change in menu item back to menu item = 30 seconds
- From menu item to main menu = 2 minutes
- From menu item to daily menu = 2 minutes

Setting range: between 1 and 10 minutes.

Factory setting: 10 min.

05 - Auto wake-up

It is possible to disengage the "Auto wake-up" function, where you can change from the screen saver to the screen with the symbols for the daily operating options by waving your hand past the control panel.

Setting range: between 0 and 4.

Factory setting: 1.

"0"	OFF
"1"	Max sensitive
"2"	Level 2
"3"	Level 3
"4"	Least sensitive

06 - Auto lightness

The display is fitted with a motion sensor.

Setting range: ON/OFF.

Factory setting: ON.

07 - Lightness day

Use this option to enter the maximum brightness level for the control panel when the room is fully lit.

Setting range: between 0 and 100%.

Factory setting: 100%.

08 - Lightness night

Use this option to enter the minimum brightness level required for the control panel when the room is completely dark.

Setting range: between 0 and 100%.

Factory setting: 30%.

09 - Lightness day screen saver

Use this option to enter the maximum brightness level for the screen saver when the room is completely lit.

Setting range: between 0 and 100%.
Factory setting: 50%.

10 - Lightness night screen saver

Use this to enter the minimum brightness level for the screensaver when the room is completely dark.

Setting range: between 0 and 100%.
Factory setting: 0%.

11 - Reset to factory settings

If the set points are so configured that the system does not function as expected and the reason for this cannot be established, there are 2 different options for resetting the menu items to the factory settings:

Press 1 to change all menu items except the menu items for Speed (Level), Filter timer, Calendar and Defrost temperatures to the factory settings.

Press 2 to change all menu items to the factory settings.

Note: Before carrying out a reset, make sure that the current input values are noted down in the "Set Point Schedule".

Setting range: between 0 and 2.
Factory setting: 0 mode.

12 - Safety menu

It is possible to prevent access to selected main menu items so that they can only be changed with a password, which is a 4-digit figure. The first time, press 4 times 0 and then "Enter". This will open items 13 to 18. Select a password in item 18. This will be the password for accessing menu items 13 to 18 in future.

13 - Date and time

If this item is set to ON, you will not be able to access the Date and time menu without the password selected in item 18.

Setting range: ON/OFF.
Factory setting: OFF.

14 - Calendar

If this item is set to ON, you will not be able to access the Calendar menu without the password selected in item 18.

Setting range: ON/OFF.
Factory setting: OFF.

15 - User menu

If this item is set to ON, you will not be able to access the

User menu without the password selected in item 18.

Setting range: ON/OFF.
Factory setting: OFF.

16 - Display

If this item is set to ON, you will not be able to access the Display menu without the password selected in item 18.

Setting range: ON/OFF.
Factory setting: OFF.

17 - Service menu

If this item is set to ON, you will not be able to access the Service menu without the password selected in item 18.

Setting range: ON/OFF.
Factory setting: OFF.

18 - Password

Use this field to enter the selected password. In the future, you will also have to use it in item 12 to access items 13 to 18. To change the password, enter a new password in this item and press "Enter". The password will now change.

5.7 Info Menu

The "Info operation menu" provides an overview of the current operating status of the unit.

If you want to see the operating status of the system over a period of operation, connect the control panel to a computer and use the Optima data logger program.

The system monitors the operating status every minute and stores the data on the SD card for up to one year..

Current temperature

Press "Enter" next to the Info menu. The first screen to be displayed shows the current temperatures..

T1	Supply air
T2	Room
T3	Fresh air
T4	Discharge air
T5	Before cooling coil
T6	Cooling coil
T7	Boiler, top
T8	Boiler, bottom
T9	Auxiliary sensor

Current fan speed

Press "Arrow down" to display the current fan speeds in per cent and the opening of the bypass damper and of the water valve.

Supply air	in %
Extract air	in %
Bypass damper	in %
Water valve	in %

Current setup of operating relays

Press "Arrow down" again to display the current status of the operating relays.

R1	Compressor
R2	Immersion heater
R3	Electrical reheater
R4	Defrosting
R5	Domestic water
R6	Room
R7	Extra cooling
R8	Auxiliary relay 8
R9	Auxiliary relay 9

Current list of alarms

Press "Arrow down" once again to display the current alarms. An alarm is activated if there is ON next to the alarm.

There is an alarm next to ON, which can also be seen on the screen saver and the display for daily operating options.

Which alarm it is is displayed in the "Info operation" menu. When the timer reaches the set value for filter change, the "Change filter" alarm will flash at the top of the screen saver. Once the error has been corrected or the filter changed and the alarm reset, the alarm will read OFF.

Error reporting	Status	Error next to "ON"
Control unit stopped	ON/ OFF	Filter not changed after 14 days./Frost protection error/The system is equipped with an external switch between terminals 28 and 29. When these have short-circuited and the system has stopped, "Alarm" will be displayed.
Change filter	ON/ OFF	The filters must be changed
Pressure switch	ON/ OFF	The high-pressure pressure switch is disconnected due to excessive pressure in the cooling system.
Frost protection	ON/ OFF	The temperature of the water after the heater is too low (frost danger).
Com error	ON/ OFF	The control panel cannot communicate with the main board (between the display and the printed circuit board).

Hour counters (2 pages)

Press "Arrow down" again to display the hour counters, which count from the day the system is put into operation. The figures displayed should be multiplied by 10. This is where you can see how many hours the system has been running, how many hours the system has run at various speeds and how many hours the relays have been connected (ON).

Total time	
Level 0	
Level 1	
Level 2	
Level 3	
Level 4	
Relay 1 Compressor	
Relay 2 Immersion heater	
Relay 3 Electrical reheater	
<i>New page comes up in the display</i>	
Relay 8 Help function	
Relay 9 Help function	

Press Exit to return to the main menu.

5.8 Service Menu

Use this function to set and change the following sub-menu items.

10 - Level 1 Supply air

Level 1, which is the lowest speed, is usually used when there is nobody home. Both fans can be configured independently of each other so that there is equal air flow in the supply air and in the extract air, which ensures optimal operation. The system must be fine-tuned using specialised air-measuring equipment. Such fine-tuning is possible without using the main regulating damper. It is not recommended to configure the air flows without expert advice. An incorrect configuration can lead to higher energy consumption or to an unpleasant indoor climate.

Setting range: between 0 and 100%.
Factory setting: 30%.

11 - Level 2 Supply air

Level 2 is the recommended speed of the system for providing optimal indoor climate, which should be adjusted to the ventilation needs of the home.

Setting range: between 0 and 100%.
Factory setting: 50%.

12 - Levels 3 and 4 Supply air

Level 3 is the highest speed that can be configured. It is used, e.g. if there are many guests or a lot of activity in the kitchen.

Setting range for level 3: between 0 and 100%.

Factory setting for level 3: 75%.

Level 4 is used, in particular, in the summer in order to lower the indoor temperature. Remember that a higher air exchange rate increases energy consumption.

Setting range for level 4: cannot be set

Factory setting for level 4: 100%.

13 - Level 1 Extract air

The fan speed is adjusted until the air flow is the same as the supply air in level 1.

Setting range: between 0 and 100%.

Factory setting: 30%.

14 - Level 2 Extract air

The fan speed is adjusted until the air flow is the same as the supply air in level 2.

Setting range: between 0 and 100%.

Factory setting: 50%.

15 - Levels 3 and 4 Extract air

The air flow at level 3 is adjusted to the same air flow as the supply air at levels 3 and 4 (item 12).

Setting range for level 3: between 0 and 100%

Factory setting for level 3: 75%.

Setting range for level 4: cannot be set

Factory setting for level 4: 100%.

16 - T2 Fine-tuning

It is possible to fine-tune the room sensor of the control panel to make it possible to view the correct current room temperature on the display.

Setting range: between 0 and -5 °C.

Factory setting: -3 °C.

17 - Timer levels 3 and 4

If automatic reconnection is used for speeds 3 or 4, it is possible to enter how many hours the system should run at level 3 or 4 before it automatically returns to level 2.

Setting range: between 1 and 9 hours.

Factory setting: 3 hours.

18 - Filter/stop

To make sure that the filters are changed when the "Change Filter" alarm flashes on the screen of the control panel, the set point can be set to ON. If the filters are not changed, the system will stop automatically after 14 days. If this precaution is not required, the set point can be configured to OFF, and the system will continue to operate.

Setting range: ON/OFF.

Factory setting: OFF.

19 - Immersion heater

If item 3 in the Service menu is set to ON and the key on the control panel for the immersion heater is activated, the immersion heater will heat up the domestic water in the upper part of boiler to the set temperature.

Setting range: between 0 and 65 °C.

Factory setting: 50 °C.

20 - Disinfection

If the item is configured to ON, the immersion heater will heat the domestic water up to 65 °C once a week in order to disinfect the boiler regardless of the temperature setting.

Setting range: ON/OFF.

Factory setting: OFF.

21 - Heating air

The default setting of the control unit is OFF in order to give priority to domestic water heating before room heating. To change the priority, the set point must be configured to ON.

Factory setting: OFF.

22 - Regulation water

If a water reheater with a motor-operated valve is installed in the system, it may be necessary to adjust the regulation time. The less the regulation time, the faster the motor-operated valve will regulate.

Setting range: between 1 and 250 sec.

Factory setting: 20 sec.

23 - Regulation power

If an electric preheater or an electric reheater is installed, it may be necessary to adjust the regulation time.

Setting range: between 1 and 30 minutes.

Factory setting: 3 min.

24 - Minimum extract air

This is where the minimum extract air flow is set. The heat pump will not start with extract air flow below this setting.

Setting range: between 0 and 100%.

Factory setting: 30%.

25 - Electric heating coil

Use this option to input if the installation is fitted with an electric heating coil:

- 0 = No electric heating coil installed
- 1 = Electric reheater installed
- 2 = Electric preheater installed

Setting range: 0-2.

Factory setting: 0.

26 - Solar collector hysteresis (°C)

If a solar collector is connected to the coil of the boiler, use this option to input the temperature difference between the temperature in the solar collector (T9) and the domestic water temperature (T8) that should be reached before the solar pump starts. The solar pump will not stop until T9 is equal to T8. The solar pump will stop under all circumstances once T8 has reached a temperature of 60 °C.

Setting range: between 0 and 5 °C.

Factory setting: 5 °C.

27 - Help function (Terminal H17 on the ES960 circuit board)

This function can be used for, as follows:

Set point	Function
0	The relay is off
1	The relay is on when the system is in operation. This option can be used, e.g. in order to open and close the fresh air damper and the discharge air damper.
2	The relay is on when extra heat is required or when the circulating pump should run when heating with water reheater is required.
3	The relay is on when the "Change filter" alarm is active. This option can be used to activate an external alarm.
4	The relay is on when extra cooling is required. This function is used if the system is also fitted with a preheater.
5	The control unit can handle an earth heat exchanger using a damper. The relay will be on in case of one of the following two conditions: The outdoor temperature, sensor T9, is lower than the value set in item 37 (frost protection temperature, typically set at 5 °C). The outdoor temperature, sensor T9, exceeds by more than 1° the temperature configured in item 1 and by more than 1° the current room temperature.
6	Floor heating control – The relay is switched on when the sensor in the tank bottom (T8) is greater than 30°C
7	Floor heating control – The relay is switched on when the sensor in the tank bottom (T8) is greater than 40°C
8	The relay is switched on when the L1 terminal is short-circuited/activated (extractor fan). This feature can be used e.g. in conjunction with a shut-off damper connected to the H17 relay which shuts off towards the bathroom when the extractor fan is activated.

Setting range: between 0 and 5.

Factory setting: 0.

28 - System stop

Use this option to choose if the system can be stopped by pressing the key for speed (K1) in the operating menu for 3-4 seconds. If the value is OFF, the system cannot be turned off.

Setting range: ON/OFF.

Factory setting: OFF.

29 - Stop defrosting

The defrosting period ends by default when the evaporator reaches a temperature of 5 °C, which is the standard setting. Under special operating conditions where the evaporator is not completely defrosted, it may be necessary to change this temperature to a higher value.

Setting range: between 0 and 15 °C.

Factory setting: 5 °C

Note: Changing this parameter without expert advice is not recommended.

30 - Compressor start/stop

The default temperature difference between start/stop compressor is ± 0.4 °C. Changing the temperature difference is recommended under special operating conditions.

Setting range: between 0.1 and 1.0 °C.

Factory setting: 0.4 °C.

Note: Changing this parameter without expert advice is not recommended.

31 - Constant ON

If the home's other heating systems are not connected to the heat pump system, the home's other heating systems, e.g. a wood-burning stove, can stop the heat pump so that the heat pump system with heat exchanger only blows preheated air into all rooms. This will cause increasing problems with draught as the temperature falls outside. Systems without heat exchangers will blow fresh air directly inside.

Setting the set point to ON will disconnect the room sensor. The unit will always operate and blow warm air in when the fresh air temperature is below the temperature set in item 32. If the set point is configured to OFF, the room sensor will regulate the unit regardless of the fresh air temperature.

Setting range: ON/OFF.

Factory setting: OFF.

32 - Constant

Use this option to set the desired fresh air temperature if constant ON is selected in item 31.

Setting range: between 0 and 10 °C.

Factory setting: 5 °C.

33 - Reduction

Lowering the supply air flow is recommended at very low fresh air temperatures in order to improve the operating conditions of the unit and to also achieve a higher supply air temperature, even though the same air flow continues to be extracted.

Setting the set point to ON will lower the supply air flow when the fresh air temperature falls below the set temperature. If the set point is set to OFF, there will be no reduction in the supply air flow. This setting should be used with care if there is a wood-burning stove installed in the home.

Setting range: ON/OFF.
Factory setting: OFF.

34 - Reduced supply air flow

When the set point is set to ON in item 33, we recommend that the fresh air temperature be set to -10 °C.

Setting range: between -15 and 0 °C.
Factory setting: -10 °C.

35 - Supply air speed

When the set point in item 33 is set to ON, we recommend that the reduced supply air flow be configured to 20% lower than the value set in item 11.

Setting range: between 0 and 100%.
Factory setting: 20%.

36 - Auxiliary relay 8 - (terminal H16 on the ES960 circuit board)

Relay 8 can be used for the following functions:

Set point	Function
0	It is possible to connect the solar pump regulated in item 26. The pump will stop when the T8 domestic hot water temperature reaches 60 °C.
1	It is possible to connect a water reheater circulation pump. The pump will only run when heat is required.
2	The relay is on when the system is running. Can be used, e.g. in order to open and close the fresh air damper and the discharge air damper.
3	It is possible to connect the solar pump regulated in item 26. The pump will stop when the T8 domestic hot water temperature reaches 52 °C.

Setting range: between 0 and 3.
Factory setting: 0.

37 - Earth heat exchanger

If an earth heat exchanger is fitted to the system and set point 5 in menu item 27 has been selected, it is possible to configure the lowest temperature at which the earth heat exchanger is to operate.

Setting range: between 0 and 10 °C.
Factory setting: 0 °C.

38 - Changing temperature scale

The menu is not in use.

39 - Minimum air supply

Use this option to set the minimum air flow for supply air. The heat pump will not start with supply air flow below this setting.

Setting range: between 0 and 100%.
Factory setting: 30%.

40 - Minimum Air Mode

0 = Off: If the value set for extract air or supply air is below the values set in items 24 and 39, respectively, the heat pump will not start when there is a need for air or water heating.

1 = Winter: Should the actual operational settings for extract air or supply air flow fall below the minimum settings in items 24 and 39, respectively, and there is a need for the heat pump to operate, the extract air volume and supply air volume will rise to the set minimum air flow rates.

On heat pump STOP, air volumes return to the values they had before the heat pump was started.

2 = Summer: When the heat pump operates in conjunction with air heating, the control unit responds as described in "1".

When the heat pump operates in conjunction with water heating and the extract air flow falls below the setting in item 24, it will go up to the setting in item 24. The supply air volume will not change, but will remain at the current setting.

On heat pump STOP, the extract air volume will return to the setting it had before "Heat pump on".

3 = Auto: When T3 (Fresh air) > 15 °C, regulation will be as if the setting in this item was 2 "Summer".

When T3 (fresh air) ≤ 15 °C, regulation will be as if the setting in this item was 1 "Winter".

Setting range: 0-3
Factory setting: 0

41 - Modbus Mode

See a separate description of MODBUS

Setting range: 0-2
Factory setting: 0

42 - Modbus address

See a separate description of MODBUS

Setting range: 1-247

Factory setting: 1

43 - Electric preheater

If an electric preheater has been installed and Service menu item 25 has been set to 2, use this option to input below the fresh air temperature at which the electric preheater is supposed to switch on.

Setting range: between -15 and 0 °C.

Factory setting: 0 °C.

44 - Preheat PI P

P-band for the PI controller for the electrical modulating preheater.

The P-band controls the amplification of the controller following a deviation from the set point (speeder)

45 - Preheat PI I

I-band for the PI controller for the electrical modulating preheater. The function controls how quickly the controller adapts to a deviation of the set point (brake).

46 - Preheat Reg

The preheat cycle function works, as follows: E.g. necessary output 50% and cycle = 60 sec means that the controller will switch the preheater on for 30 sec and then off for another 30 sec.

Note: Please refer to your country-specific regulations on limitations when adjusting this function.

The modulating preheater function refers to the value adjusted in set point no. 43. The preheater will try to maintain a steady outdoor air temperature according to this set point. When the modulating preheater is used, the existing outdoor air temperature sensor (T3), which is built into the ventilation unit, can be used as reference. No extra temperature sensor is required.

47 - Reheat offset

Offset for reheater with reference to the set point for the requested temperature on the display (user menu 01). For example, the desired temperature = 20 °C offset value=2 the reheater will try to maintain a supply air temperature of 18 °C.

48 - Reheat PI P

P-band for the PI controller for the electrical modulating reheater. The P-band controls the amplification of the controller following a deviation from the set point (speeder).

49 - Reheat PI I

I-band for the PI controller for the electrical modulating preheater. The function controls how quickly the controller adapts to a deviation of the set point (brake).

50 - Reheat Reg

The reheat cycle function works, as follows: For example, necessary output 50% and cycle = 60 sec means that the controller will switch the preheater on for 30 sec and off for another 30 seconds.

Note: Please refer to your country-specific regulations on limitations when adjusting this function.

The modulating reheater function refers to the value adjusted in set point no. 01. The reheater will try to maintain a steady supply air temperature according to this set point.

When using the modulating reheater, it will be necessary to replace the inlet air temperature sensor (T1) in the ventilation unit with a new temperature sensor installed upstream of the reheater.

51 - Bypass max

Use this option to set the temperature at which the bypass should be 100% open. You set a temperature differential, which means that if you want the bypass to be 100% open, at e.g. 23 °C and if the set temperature in User menu item 1 is 20 °C, this menu item should be set to 3 °C.

The bypass will open, provided that:

1. The extract air temperature is higher than the fresh air temperature.
2. The fresh air temperature is above the temperature set in the Service menu menu 52.

The bypass opens when the temperature reaches the set point in User menu item 1 + the temperature differential set in this menu item.

Note. The bypass and reheater cannot run simultaneously.

52 - Close bypass at low fresh air

To prevent the bypass damper from opening at fresh air temperatures and from blowing cold, unheated air into the dwelling, use this function to configure the lowest fresh air temperature at which the damper must be closed. The value is an expression of the greatest difference that may exist between the temperature configured in item 1 and the lowest fresh air temperature. Setting range: Between 0 and 20 °C. If 0 °C is selected, the function is turned completely off.

53 - Method of regulation

Use this option to set which sensor will be used as a reference point for the desired set point temperature.

There are 2 options:

1. Extract air sensor in unit (T2S)
2. Sensor in display (T2)

If it is not possible to place the display with the built-in temperature sensor in a room that is “representative” for the overall temperature in the entire home, we recommend that you use the T2S extract air sensor as reference sensor.

54 - Demand control

This feature allows the connection of an external 0–10 volt signal which can be used to force-control fans to a higher speed as a result of an intensification of the signal.

The function is only active in fan steps 2 and 3 and requires the humidity control to be disabled (user menu 06).

The factory setting is 0%, which disables the demand control. The working range of the allowable increase in fan speed can be limited by setting it from 0–100%

Example: working range of 100%. Here, 5 volts will increase the speed by +50%

Example: working range of 50%. Here, 5 volts will increase the speed by +25%

55 - Humidity max. temperature**

Sets the end point for the outdoor temperature compensation (T3).

Options: 5–25°C.

56 - Humidity max. value**

Setting the end point of the outdoor temperature compensation, (desired max. humidity value).

Options: 35–85 %.

57 - Humidity fan speed**

Sets how much the fan speed can deviate from the desired fan speed.

Options: 5–30 %.

58 - Humidity control frequency**

Sets the desired frequency for how often the fan speed can be changed.

The function is defined as 1% per unit of time.

Options: 1–60 mins.

59 - Fire damper*

If the Optima controller is used in a fire and smokesafety system, this menu allows the setting of the number of dampers which are connected to the Optima controller and need to be monitored.

Options:

0 = the function is disabled

1 = 1 damper is connected

2 = 2 dampers are connected

3 = 3 dampers are connected

4 = 4 dampers are connected

60 - Fire test now*

0 = auto, dampers are tested 1 time per week in accordance with the schedule.

1 = Fire test now, this function force starts a functional test of fire dampers. The result will appear on the display and be logged on the SD card (note: there will be a delay of up to 240 seconds from when the test starts to when the test has been performed).

2 = reset fire alarm, in case of errors during damper test, triggered damper/smoke detector or a lack of communication, the ventilation unit will be shut down and an alarm symbol will appear on the display. In order to restart the system, perform a reset of the fire control system.

61 - Fire test day*

Calendar of when the automatic weekly fire/smoke damper test will be performed

1 = Monday

2 = Tuesday

3 = Wednesday

4 = Thursday

5 = Friday

6 = Saturday

7 = Sunday

62 - Fire test hour*

schedule for when the automatic fire/smoke damper test will be performed.

Options: 1–24

*NOTE – This function can only be used in conjunction with the ES960CC PCB and ES1048 firebox.

When activating menu 59, under the Info menu, a ‘FireTST’ point will be added which indicates the time when the last fire test was performed, as well as the status of this test.

Furthermore, there will be a ‘Fire alarm’ point which, if listed as ON, will indicate damper errors and simultaneously identify which damper is failing. If Fire alarm is OFF after performing ‘fire test now point 60’ and setting the correct number of dampers, the installation has been done correctly.

** Humidity control parameters are only relevant to Combi models with humidity sensors.

5.9 Schedule for Week Program

Monday				
	Hours	Minutes	Speed	Red.T2
1)				
2)				
3)				
4)				
5)				
6)				
7)				
8)				
9)				
10)				

Tuesday				
	Hours	Minutes	Speed	Red.T2
1)				
2)				
3)				
4)				
5)				
6)				
7)				
8)				
9)				
10)				

Wednesday				
	Hours	Minutes	Speed	Red.T2
1)				
2)				
3)				
4)				
5)				
6)				
7)				
8)				
9)				
10)				

Thursday				
	Hours	Minutes	Speed	Red.T2
1)				
2)				
3)				
4)				
5)				
6)				
7)				
8)				
9)				
10)				

Friday				
	Hours	Minutes	Speed	Red.T2
1)				
2)				
3)				
4)				
5)				
6)				
7)				
8)				
9)				
10)				

Saturday				
	Hours	Minutes	Speed	Red.T2
1)				
2)				
3)				
4)				
5)				
6)				
7)				
8)				
9)				
10)				

5.10 Defrosting Schedule

Sensor TP before cooling surface °C	Sensor TP cooling surface °C
15	-2
14	-2
13	-2
12	-2
11	-2
10	-2
9	-2
8	-2
7	-2
6	-2
5	-2
4	-2
3	-3
2	-4
1	-4
0	-5
-1	-6
-2	-6
-3	-7
-4	-7

Sunday				
	Hours	Minutes	Speed	Red.T2
1)				
2)				
3)				
4)				
5)				
6)				
7)				
8)				
9)				
10)				

Red. T2 = Reduced room temperature (Night set-back)

5.11 Set Point Schedule

Item	Heading	Factory setting:	Configuration area	Date	Date	Date	Date
(5.5) 1	Temperature	21 °C	10 - 30 °C				
2	Domestic water	52 °C	0 - 55 °C				
3	Immersion heater	OFF	ON/OFF				
4	Timer levels 3 and 4	OFF	ON/OFF				
5	Filter change	3 months	0 to 12 months				
6	Humidity control	OFF	ON/OFF				
(5.8) 10	Level 1 Supply air	30%	0 - 100%				
11	Level 2 Supply air	50%	0 - 100%				
12	Levels 3 and 4 Supply air	75/100%	0 - 100%				
13	Level 1 Extract air	30%	0 - 100%				
14	Level 2 Extract air	50%	0 - 100%				
15	Levels 3 and 4 Extract air	75/100%	0 - 100%				
16	T2 Fine-tuning	±3 °C	± 5 - 0 °C				
17	Timer levels 3 and 4	3 hours	1 - 9 hours				
18	Filter / stop	OFF	ON/OFF				
19	Immersion heater	50 °C	0 - 65 °C				
20	Disinfection	OFF	ON/OFF				
21	Heating air	OFF	ON / OFF				
22	Regulation water	20 sec.	1 - 250 sec.				
23	Regulation power	3 min.	1 - 30 min.				
24	Min extract air	30%	0 - 100%				
25	Electric heating coil	0	0-2				
26	Solar collector	5 °C	0 - 5 °C				
27	Help functions	0	0 - 8				
28	System stop	OFF	ON/OFF				
29	Stop defrosting	5 °C	0 - 15 °C				
30	Compressor start/stop	0.4 °C	0.1 - 1.0 °C				
31	Constant ON	OFF	ON/OFF				
32	Constant	5 °C	0 - 10 °C				
33	Reduction	OFF	ON/OFF				
34	Reduced supply air flow	±10 °C	±15 - 0 °C				
35	Supply air speed	20%	0 - 100%				
36	Auxiliary relay 8	0	0/1/2/3				
37	Earth heat exchanger	0 °C	0 - 10 °C				
38	Changing temperature scale	OFF	ON/OFF				
39	Minimum supply air	30%	0 - 100%				
40	Minimum Air Mode	0	0/1/2/3				
41	Modbus Mode	0	0/1/2				
42	Modbus Address	1	1-247				
43	Electric preheater	0 °C	-15 - 0 °C				
44	Preheat PI (P)	5	1 - 255				
45	Preheat PI (I)	200	1-255				
46	Preheat Reg. (s)	40	10-120				
47	Reheat offset (-)	2	0-20 °C				
48	Reheat PI (P)	5	1 - 255				
49	Reheat PI (I)	200	1-255				
50	Reheat Reg. (s)	40	10-120				

51	Bypass maximum	3	1-10				
52	Close bypass at low fresh air	4	0-20 °C				
53	Reg. form (1=T2S 2=T2D)	2	1-2				
54	Demand control	0	0-100%				
55	Humidity max. temperature	15°C	5-25°C				
56	Humidity max. value	60 %	35-85 %				
57	Humidity fan speed	15 %	5-30 %				
58	Humidity control frequency	10 min.	1-60 min.				
59	Fire damper	0	0-4				
60	Fire test now	0	0-2				
61	Fire test day	3	1-7				
62	Fire test hour	12	1-24				

6. FUNCTION

6.1 Operation of Optima 312

A Combi unit is used for heating domestic water and supply air in order to cover the ventilation needs of the home and partial basic heating.

Domestic water heating

The temperature of the domestic water is controlled by sensor T8, which is fitted at the bottom of the boiler. When the domestic water needs to be heated, the compressor starts, solenoid valves MA 3 and MA 6 open, and the domestic water is heated to the configured domestic water temperature.

Room heating

Solenoid valves MA 2 and MA 5 are activated for room heating. Room temperature is controlled by room sensor T2, which is fitted in the control panel, or by extract air sensor T2S, which is fitted in Combi 185. If this temperature has been set to, e.g. 2 °C, the compressor will start when the room temperature falls to 20.6 °C. The compressor will stop when it has increased the room temperature to 21.4 °C. If the compressor cannot maintain the room temperature, the motor-operated valve (systems with water reheaters) will begin to regulate (PI regulation) once the room temperature has fallen to 20 °C.

For systems with electrical reheaters, level 1 will engage when the room temperature falls to 20 °C. When the room temperature again reaches 21 °C, the electrical heater will disengage.

No heat requirement

When neither domestic water heating nor room heating is required, the compressor stops, but the fans continue to run and the heat of the extract air is recovered in the counter current heat exchanger and transferred to the supply air.

Defrosting

The system begins to defrost when the difference between the temperature before the cooling coil and the temperature of the cooling coil becomes too big, which occurs when ice forms on the cooling coil. Solenoid valve MA 4 opens, the supply air fan and the electrical heaters stop until the ice has melted and the cooling coil has reached a temperature of about 5 °C (depends on the value set in menu 29). The solenoid valve then closes again, and the supply air fan and the electrical heating coils start again.

6.2 Extra Capacity

Immersion heater

If the heat requirement exceeds the capacity of the Combi unit, the immersion heater can be configured to ON using the shortcut key in the main menu. When the immersion heater is set to ON, sensor T7, which is mounted in the middle of the boiler, will heat the upper part of the DHW boiler to the temperature that is set.

6.3 Operational Reliability

High-pressure pressure switch

In order to prevent the compressor from exceeding its range of application, there is a built-in high-pressure pressure switch that will disconnect when the pressure becomes too high. Activate the red reset button on the pressure switch once the cause of the fault has been established.

Safety thermostat

If a fault occurs in the immersion heater for heating of domestic water, the safety thermostat will disconnect. To reconnect the safety thermostat, press the small button in the middle of the thermostat.

The thermostat is located in the middle of the boiler.

Remember to disconnect the power to the system before engaging in an intervention. Such intervention may only be performed by authorised personnel.

Overriding the supply air fan

If the supply air temperature exceeds 45 °C, the speed of the supply air fan will begin to increase.

The supply air temperature will be maintained at 45 °C, if possible.

7. MAINTENANCE

To achieve optimal performance, follow the instructions below:

 Before opening the unit, disconnect power / pull out the plug and wait until the fans have stopped completely.

Check that the condensation outlet is working a couple of days after the primary installation.

Environmental requirements

When repairing or dismantling the unit, observe the statutory and environmental regulations and requirements regarding recycling and destruction of various materials.

7.1 Unit

Filters

Change the filters when the “change filter” alarm flashes on the display of the control panel. Stop the unit using the circuit breaker of the unit or the circuit breaker of the terminal board. Open the front cover/filter drawers and remove the filters. After changing the filters, reset the filter timer. The time interval for cleaning/changing the filters can be adjusted in the operating menu.

 The discs are sharp, be careful not to cut yourself. Do not damage the discs. Vacuum cleaning or using pressurised air on the filters is not recommended as it may impair filter performance.

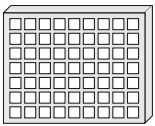

G4 = Standard filter (Coarse filter class G4)

F5 = Fine filter (Fine filter class F5)

F7 = Pollen filter (Fine filter class F7)

Condensed water and condensation outlet

The condensation trays must be cleaned of dirt every autumn. Fill the condensation trays with water and check that the water drains away. If not, the outlets must be cleaned. Also check that the evaporator discs are clean.

Heat exchanger

Inspect the heat exchanger every year. If it is dirty, take it out and wash it in warm water with soap and rinse it with a hand shower.

Fans

Inspect the fans for dirt in the fan wheels every year.

Remove the front cover of the unit. Clean the fans with a brush, a bottle cleaner or a paint brush. Be careful not to remove the counterbalancing weights on the fan wheels as this will lead to disequilibrium and cause a higher level of noise and also wear the fans.

Supply air and extract air valves

Clean the valves by drying with a dry cloth. Make sure that the valves do not turn around, causing a change in the air flow.

7.2 Water Circuit and Boiler

Safety valve

In connection with the domestic water boiler, the installer has fitted a safety valve next to the cold water tap. The function of this valve is to protect the boiler against overpressure when domestic water expands under heating.

The non-return (check) valve that is fitted before the safety valve on the cold water pipe prevents the water from flowing back into the cold water pipe. The pressure increases to the maximum of the safety valve. Then the safety valve opens, and the excess water flows away. If the safety valve does not open, the boiler will burst. To ensure that the safety valve is functional, it should be inspected several times a year. To test it, press the handle on the safety valve and ensure that the water can drain away. Damage that has occurred due to a blocked safety valve is not covered by the guarantee.

7.2.1 Anode (only relevant to Combi with enamelled tank)

In order to prevent corrosion of the enamelled hot water tank, it has been equipped with a magnesium anode which is mounted in the middle of the tank.

The anode has a life expectancy of around 2–5 years. However, caution should be taken to ensure that the anode is intact. Every two years, it is recommended that the anode is inspected and replaced if it has been corroded and shows a diameter of around 6–10 mm.

When the anode is to be inspected, the voltage must be disconnected before removing the front cover.

The hot water tank must be emptied of water before it is possible to remove the anode. To do this, turn off the cold water supply and attach a hose to the drain valve so that water from the tank can run out into the nearest drain. When draining the water, open a hot water tap in order to prevent negative pressure in the tank. When the tank has been emptied, the anode can be unscrewed and serviced. Once the anode has been fitted again, close the drain valve, reactivate the cold water supply, and the tank will be filled with water and emptied of air again.

When the tank has been filled with water, reinstall the front cover, and the voltage can be switched back on.

7.3 Dismantling/Taking the System Out of Service

Do as follows:

Disconnect the power supply, i.e. the electric cables. Disconnect the condensation outlet and the power cables to any reheater/preheater. Disconnect the wires to the panel and dismantle the ducts. If the system needs to be taken out of service, dismantle the ducts to avoid condensed water in the system and in the ducts. Close all supply air and extract air valves.

8. TROUBLESHOOTING

8.1 High-Pressure Pressure Switch

The high-pressure pressure switch protects the heat pump from excessive pressure in the cooling circuit. In the event of disturbances, the high-pressure pressure switch will stop the compressor.

The system will restart when the high-pressure pressure switch is reset manually.

Before unscrewing the front cover, disconnect power to the system.

Take off the front cover by removing the screws.



To RESET, press the **red** button.

8.2 Immersion Heater's Safety Thermostat

If sensor T7 of the immersion heater is defective, the safety thermostat ensures that the temperature of the domestic hot water does not exceed 90 °C.

Before unscrewing the front cover, disconnect power to the system.

Unscrew the cover plate in front of the immersion heater and reset the safety thermostat, as indicated in the picture.

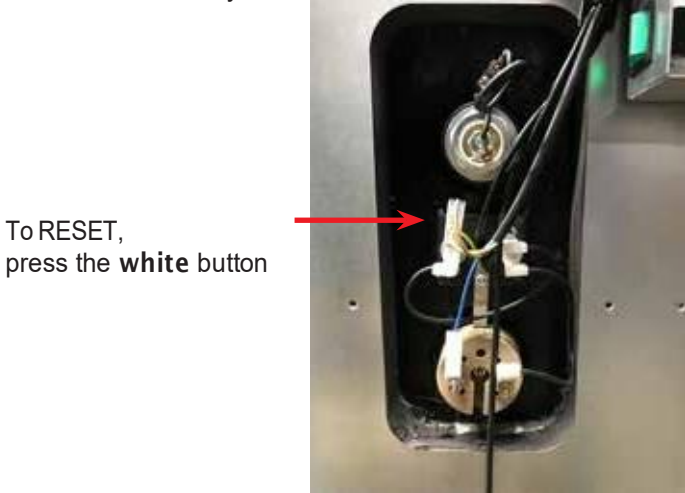

To RESET, press the **white** button

8.3 System Is Not in Operation

The system has stopped.

Check the following:

- Is the display illuminated?
- Is the system disconnected via the clock program?
- Is the high-pressure pressure switch disengaged?
- Is the cable between the control unit and the control panel attached?
- Has the filter been changed? ("Change filter" alarm)
- Frost protection error.

Condensed water is leaking from the unit

Error possibility:

- The condensation outlet is blocked by dirt.
- The condensation outlet is not adequately protected against freezing at low outdoor temperatures.
- The drain trap is not installed correctly.

8.4 Air Faults

No supply air to the living rooms.

Error possibility:

- Blocked fresh air filter.
- The fresh air filter is blocked by dirt and leaves in the autumn or by snow and ice in the winter.
- Unit is defrosting.

No extract air from the wet rooms

Error possibility:

- Blocked extract air filter.

Cold supply air

Error possibility:

- The heat exchanger is blocked by dirt or ice.
- Blocked extract air filter.
- "Opening bypass" incorrectly set in the control unit or a defective bypass.

If it is not one of the faults above, contact:

- *During the warranty period (0-2 years):* the fitter that the unit was bought from.